

## YDS-G5M7V2+YDS-CMFL0272-IMX586 V1.0 Ai Master Board + 48MP Sony IMX586 Fixed Focus Camera Module Development Kit

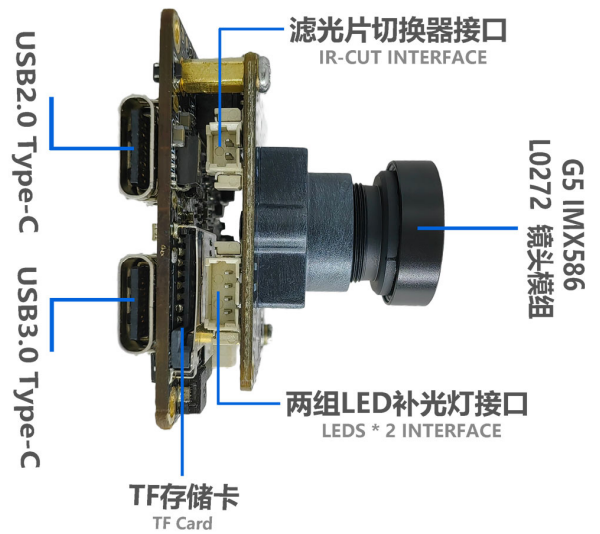

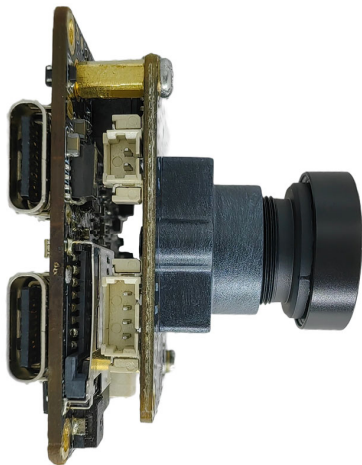

## YDS-G5M7V2+YDS-CMFL0272-IMX586 V1.0 Ai Master Board + 48MP Sony IMX586 Fixed Focus Camera Module Development Kit

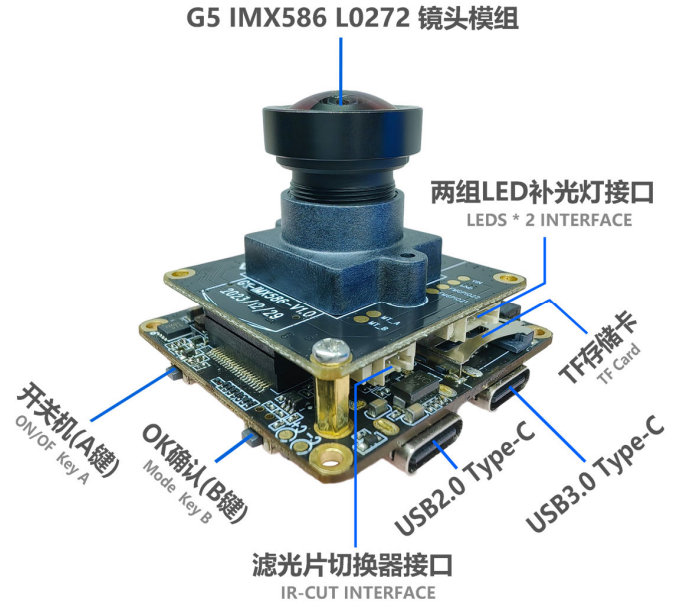
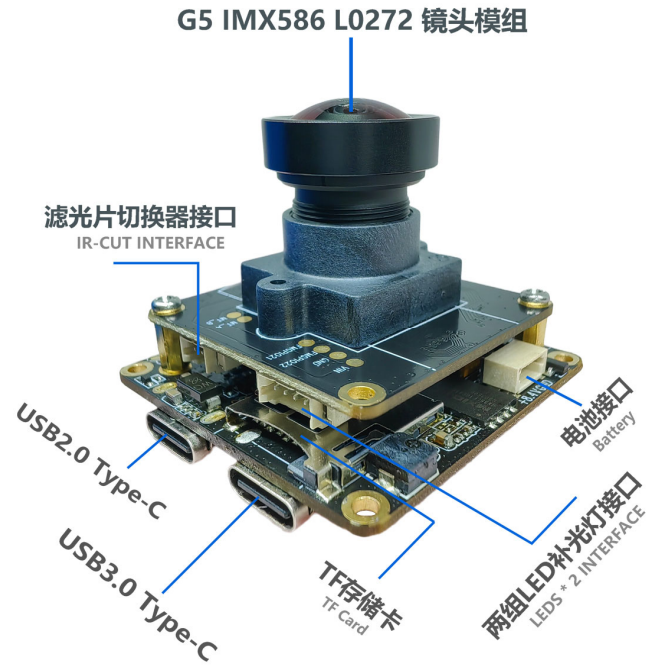
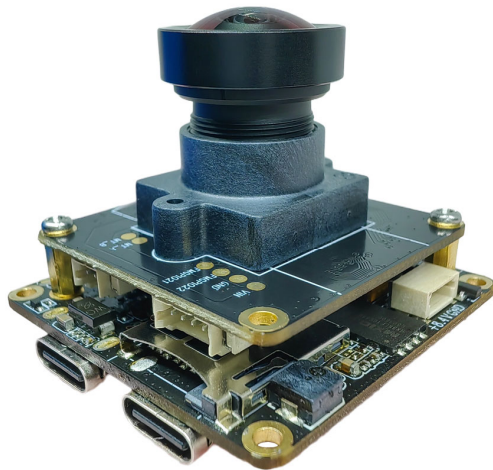

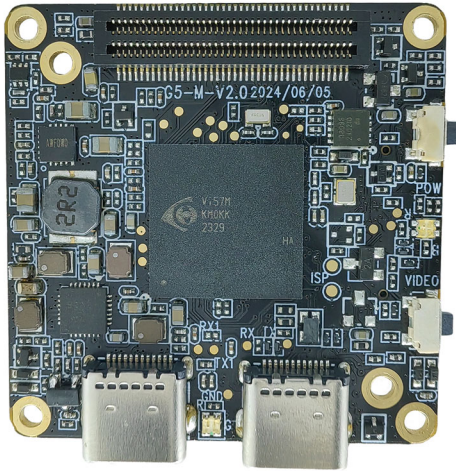
**YDS-G5M7 V2.0****iCatch V57 Ai-Powered Image Processing SoC Master Board**

Front View

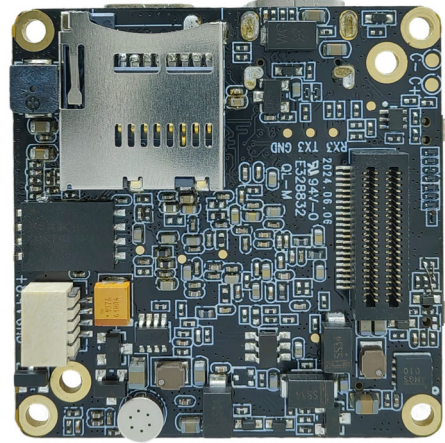

Back View

**Overview**

Equipped with iCatch V57, built-in 2GB DDR3, supports up to 4K@30FPS, 1080P@120FPS H.264 encoded video. Onboard support for Type-C, TF memory card, video recording, 2 control buttons, buzzer, battery power supply, etc.

This master board extension also supports WiFi, display, CVBS, lens camera module, UART, I2C, SPI, PWM, MIC and other expansion interfaces. The board size is 38x38mm. Widely used in drones, mini DV, wearable devices, sports cameras, face recognition, USB cameras and other camera products.



## YDS-G5M7 V2.0

### iCatch V57 Ai-Powered Image Processing SoC Master Board

#### Hardware Specifications

<b>Model No.</b>	<b>YDS-G5M7 V2.0</b>
<b>Main Control Chipset (DSP)</b>	iCatch V57
<b>Image Sensor Interface</b>	MIPI
<b>Battery Voltage</b>	7.4V - 7.7V High Voltage Lithium Battery
<b>Storage Type</b>	External TF Card, Supports 8GB - 512GB Class 10 and Above, U3 is Recommended
<b>Type-C Port</b>	Type-C USB 5V Connection to Computer USB Mode Connection to PCCAM (Camera) Mode Type-C 2.0 Interface, Type-C 3.0 Interface
<b>LED Indicator Type</b>	Three Color Light (Red, Green, Blue)
<b>2 Control Button Type</b>	Power Button (A), OK Button (B)
<b>Power Supply</b>	Supports 3 Power Supply Methods At The Same Time (1) 5V USB to Type-C Port Power Supply (2) 9V-24V WiFi Board Power Supply (3) 6.8V-8.4V Battery Power Supply
<b>Operating Temperature</b>	-10°C to +60°C Without Housing
<b>Storage Temperature</b>	-20°C to +80°C
<b>Humidity</b>	20% to 80%
<b>PCB Dimensions</b>	38 x 38 mm
<b>PCB Screw Hole Spacing</b>	External (34mm x4), Internal (28mm x2)
<b>PCB Screw Hole Diameter</b>	2 mm
<b>Optional Camera Configuration</b>	(1) YDS-G5M7 V2.0 + Camera (2) YDS-G5M7 V2.0 + Camera + YDS-G1WF V6.3 WiFi Board
<b>Supportive Image Sensors</b>	48MP: IMX586 12MP: IMX577
<b>Optional Extension Ports</b>	WiFi, Camera Module, UART, I2C, SPI, IO etc.

## YDS-G5M7 V2.0

### iCatch V57 Ai-Powered Image Processing SoC Master Board

#### Photo and Video Resolution

<b>Video Resolution</b>	4K@24/25/30/FPS 2.7K@24/25/30/48/50/60FPS 1080P@24/25/30/48/50/60/120FPS 720P@24/25/30/48/50/60/120/240FPS
<b>Photo Resolution</b>	48MP (8000x6000) 14MP (4592x3056) 12MP (4000x3000) 10MP (3648x2736) 8MP (3264x2448) 5MP (2592x1944) 3MP (2048x1536) 2MP (1920x1080)

### Wifi、显示屏、uart、PWM等扩展接口

For Wifi, Display, uart, PWM Etc

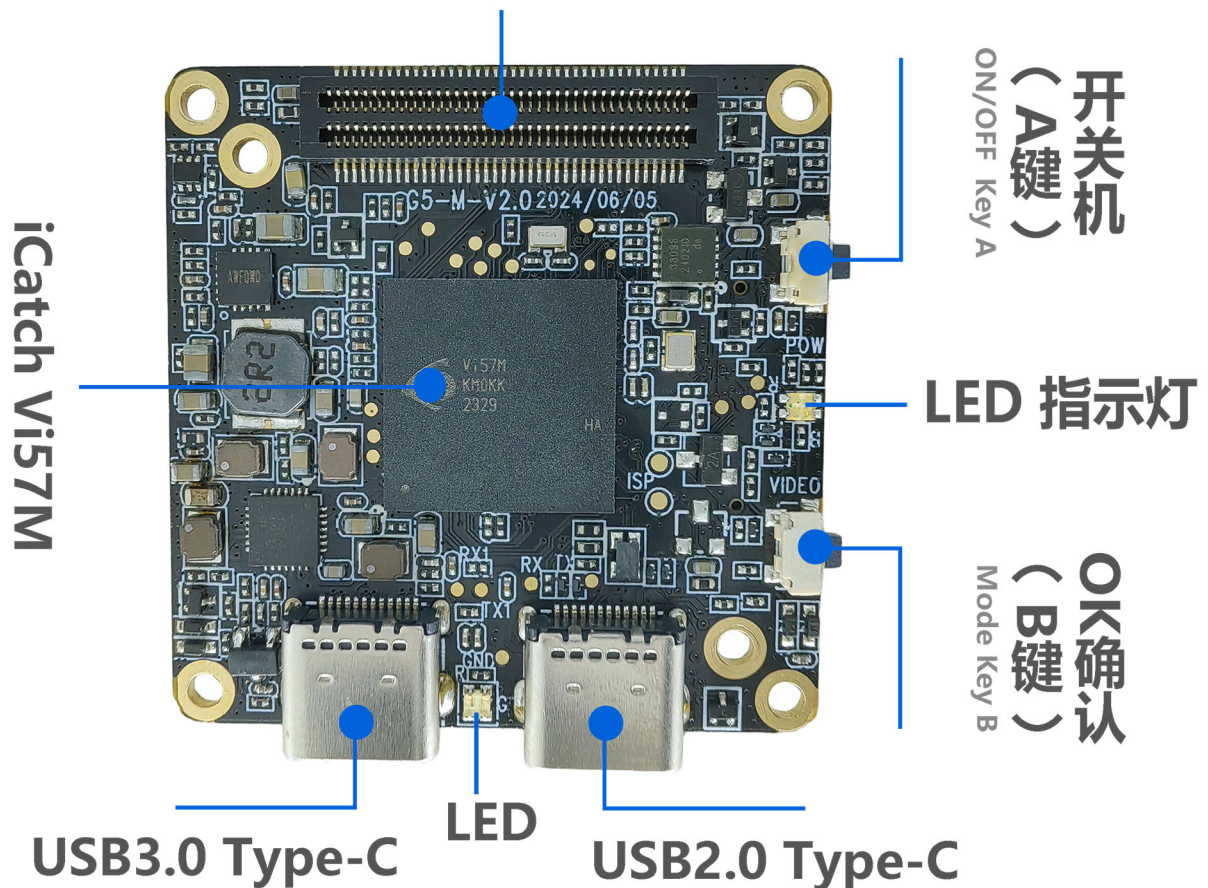



## YDS-G5M7 V2.0

### iCatch V57 Ai-Powered Image Processing SoC Master Board

#### USB Type-C Interface:

This interface supports USB standard 5V power input, which can power the master board and charge the battery (recommended 7.4V-7.7V battery). Connecting to a computer can directly read files in the TF card and use it as a USB flash drive. It can also be used as a PCCAM USB camera.

#### Connecting to the Computer USB Flash Drive Mode:

Insert the TF card, connect the other end of the USB to the computer, and automatically enter the USB flash drive mode after booting by default.

#### Connecting to the Computer PCCAM Mode:

Insert the TF card, connect the other end of the USB to the computer, and automatically enter the USB flash drive mode after booting. Short press the OK button (A) to switch to PCCAM camera mode. (Right-click the computer "Computer", click the left button in the pop-up prompt box to enter "Management", "Device Manager", and you can see the name of the camera identified in "Image Device" camera. Open the camera tool "amcap.exe" to see the current device preview screen).

#### Type-C USB 2.0 and USB 3.0 Interfaces:

USB 2.0 Type-C interface: retains the camera control serial port UART3 and the camera debugging serial port UART1 (the serial port function can be used with the USB serial port debugging board).

USB 3.0 Type-C interface: connected to a computer with a USB 3.0 port, it can achieve high-speed data transmission function, greatly shortening the data transmission time.

#### Battery Power Supply:

6.6V (low power shutdown) to 8.8V, 7.4-7.7V high-voltage and high-density batteries are recommended.

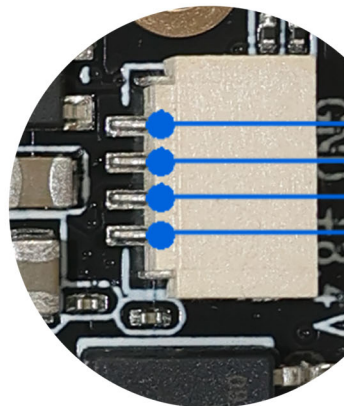
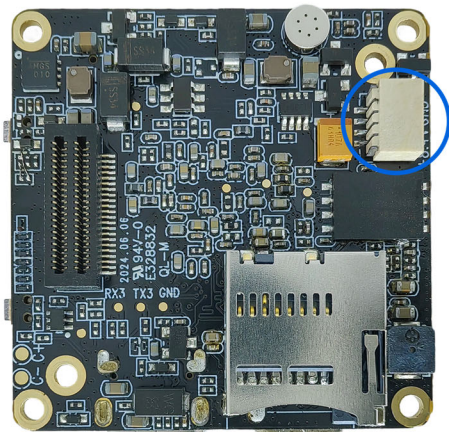

BAT -  
BAT +

Battery 7.7V-8.8V  
电池供电

## YDS-G5M7 V2.0

### iCatch V57 Ai-Powered Image Processing SoC Master Board

#### Camera Module:

This interface can be used to expand multiple MIPI sensors, IR-CUT functions, LED filled light, UART2 serial port, battery power output, and other functions.

Some camera modules can be used with coaxial cable extended connection via the YDS-G1CA V1.0 adapter plate, which is convenient for users to assemble flexibly.

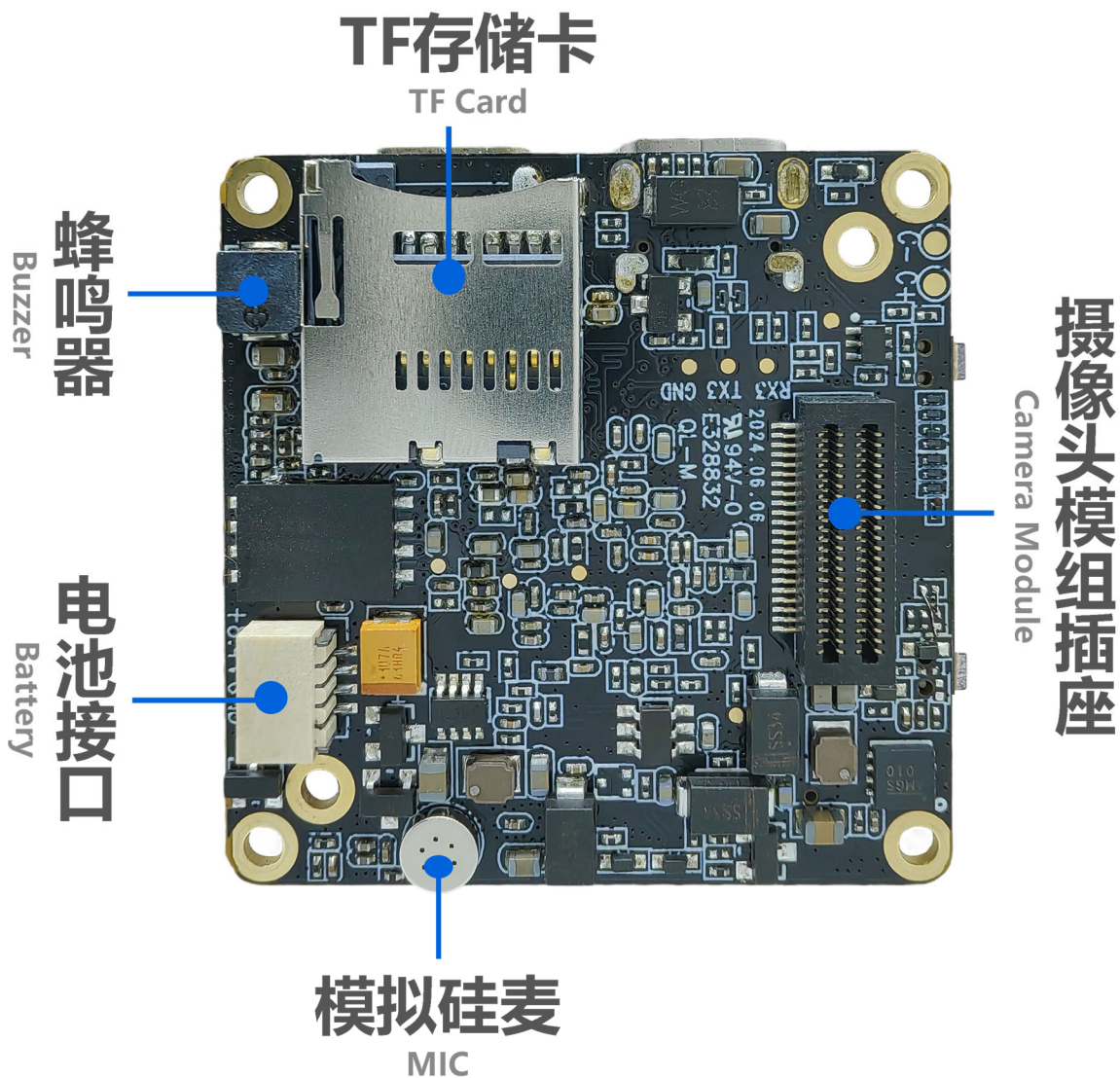

## YDS-G5M7 V2.0

### iCatch V57 Ai-Powered Image Processing SoC Master Board

#### LED Indicator Description:

Functions	Color	Power On	Video Mode	Video Recording	Photo Mode	Photo Snapshot
LED Indicator	Red	Always On	Always On	Flashing		
	Green				Always On	Flash Once
	Blue					

#### Special Note:

When the device is powered on without a TF card inserted, the function indicator light flashes yellow.

#### Buzzer Sound Description:

Operation Mode	Power On	Power Off	Switching Mode	Start Video Recording	Start Stop Recording	Photo Snapshot
Buzzer Sound	3 Beeps	5 Beeps	1 Beep	1 Beep	2 Beeps	1 Beep

#### Special Note:

In each mode, when the device presses a button, you hear the buzzer "beep" sound.

#### Button Instructions:

Button	Mode or Status	Functional Operation
<b>Button A</b> Power Mode	Power ON / OFF	Long Press 1 Second Power ON / OFF
	Standby	Short Press on Switch Mode Video Recording, Snapshot
<b>Button B</b> Confirmation OK Video Recording	Standby	In Video Standby Mode, Long Press 3 Seconds to Turn ON / OFF WiFi Mode. Default WiFi is OFF. In Video Recording Mode, Short Press to Start Recording In Snapshot Mode, Short Press to Start Taking Photo
	Shutdown	Press and Hold to Enter the USB Burning Mode
<b>Reset Function</b>	Standby or Working	Press Button A and B at the Same Time to Shutdown



## YDS-CMFL0272-IMX586 V1.0

### 48MP Sony IMX586 Fixed Focus Camera Module

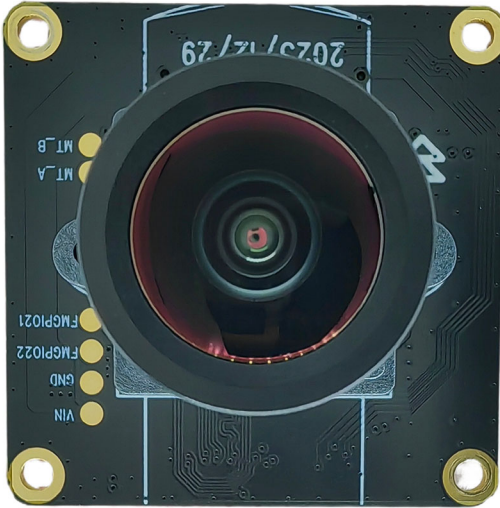

Front View

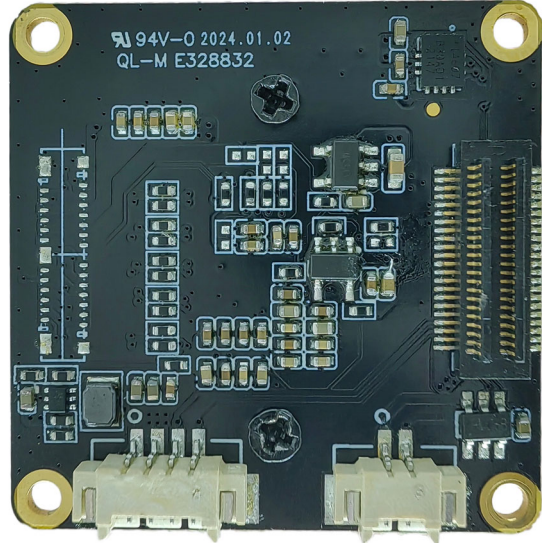

Back View

## Overview

The YDS-CMFL0272-IMX586 V1.0 camera module uses the Sony IMX586 high-quality CMOS sensor, which has a diagonal of 8.0mm (Type 1/2.0) CMOS image sensor, 0.8x0.8um pixel, color square pixel display, 48 effective megapixels, and high-definition images.

When used with the master board, it can support 48MP pixel high-definition photography and up to 4K@30FPS video recording, with the characteristics of true color reproduction and excellent image quality. It is connected using a board-to-board socket. The board frame size is 32x32mm.

## YDS-CMFL0272-IMX586 V1.0 48MP Sony IMX586 Fixed Focus Camera Module

G5 IMX586 L0272 镜头模组

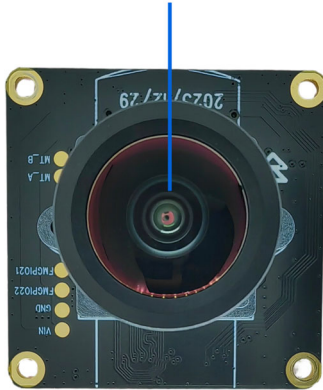

Top View



Side View

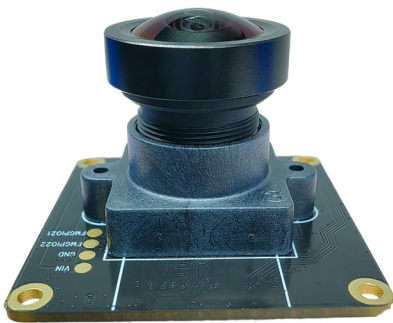

Bottom View



Isometric View



## YDS-CMFL0272-IMX586 V1.0 48MP Sony IMX586 Fixed Focus Camera Module

### Specifications

<b>Model No.</b>	<b>YDS-CMFL0272-IMX586 V1.0</b>
<b>Image Sensor</b>	IMX586
<b>Image Sensor Type</b>	CMOS
<b>Effective Pixels</b>	48 Megapixels
<b>Sensor Size</b>	1/2.0"
<b>Pixel Size</b>	0.8um x 0.8um
<b>Video Frame Rate</b>	4K@24/25/30/FPS 2.7K@24/25/30/48/50/60FPS 1080P@24/25/30/48/50/60/120FPS 720P@24/25/30/48/50/60/120/240FPS
<b>Photo Resolution (with Master Board)</b>	48MP (8000x6000) 14MP (4592x3056) 12MP (4000x3000) 10MP (3648x2736) 8MP (3264x2448) 5MP (2592x1944) 3MP (2048x1536) 2MP (1920x1080)
<b>Operating Temperature</b>	-10°C to +60°C
<b>Storage Temperature</b>	-20°C to +80°C
<b>Humidity</b>	20% to 80%
<b>PCB Dimensions</b>	32 x 32 mm
<b>Module Size</b>	32 x 32 x 28 mm
<b>PCB Screw Hole Spacing</b>	28 x 28 mm
<b>PCB Screw Hole Diameter</b>	2 mm
<b>Lens Mount Screw Diameter</b>	1.6 mm

## YDS-CMFL0272-IMX586 V1.0 48MP Sony IMX586 Fixed Focus Camera Module

### Lens Specifications

Lens Model No.	L0272
EFL (Focal Length)	2.7 mm
TTL (Total Length)	17.94 mm
F. No.	2.0
Diagonal View Angle (DFOV)	175° (DFOV) (y' = 8.812 mm)
Horizontal View Angle (HFOV)	152° (HFOV) (y' = 7.68 mm)
Vertical View Angle (VFOV)	88° (VFOV) (y' = 4.32 mm)
Distortion	<-93%
Relative Illumination	>40%
Lens Operating Temperature	-30°C to +75°C
Lens Storage Temperature	-40°C to +85°C

### Lens Drawing

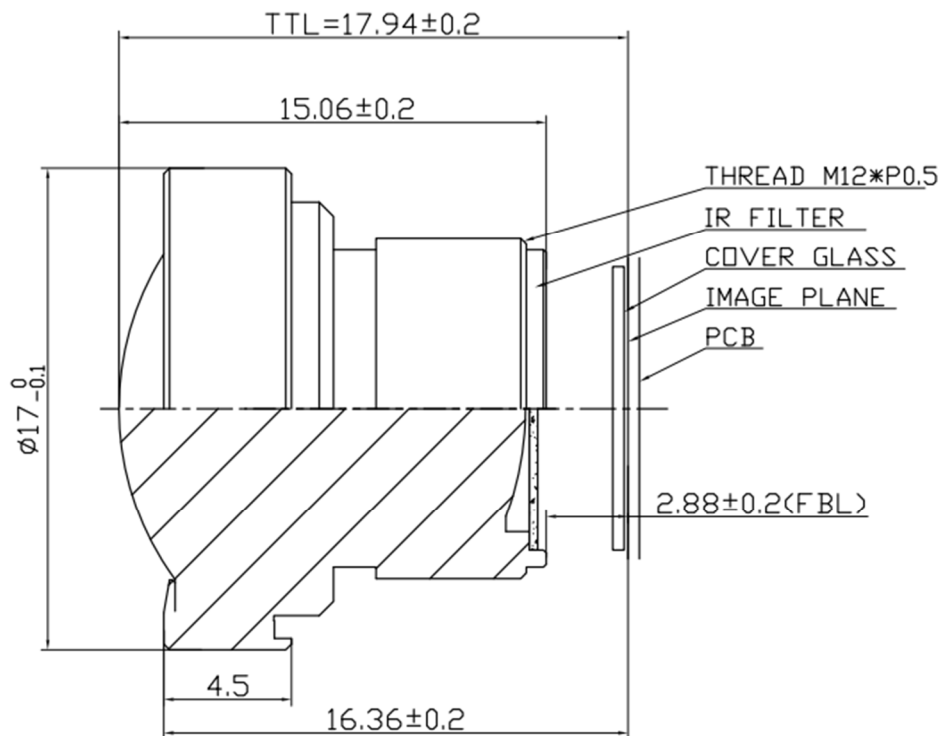

## YDS-CMFL0272-IMX586 V1.0

## 48MP Sony IMX586 Fixed Focus Camera Module

## 通过板对板连接器连接G5主板

## Connect Sensor

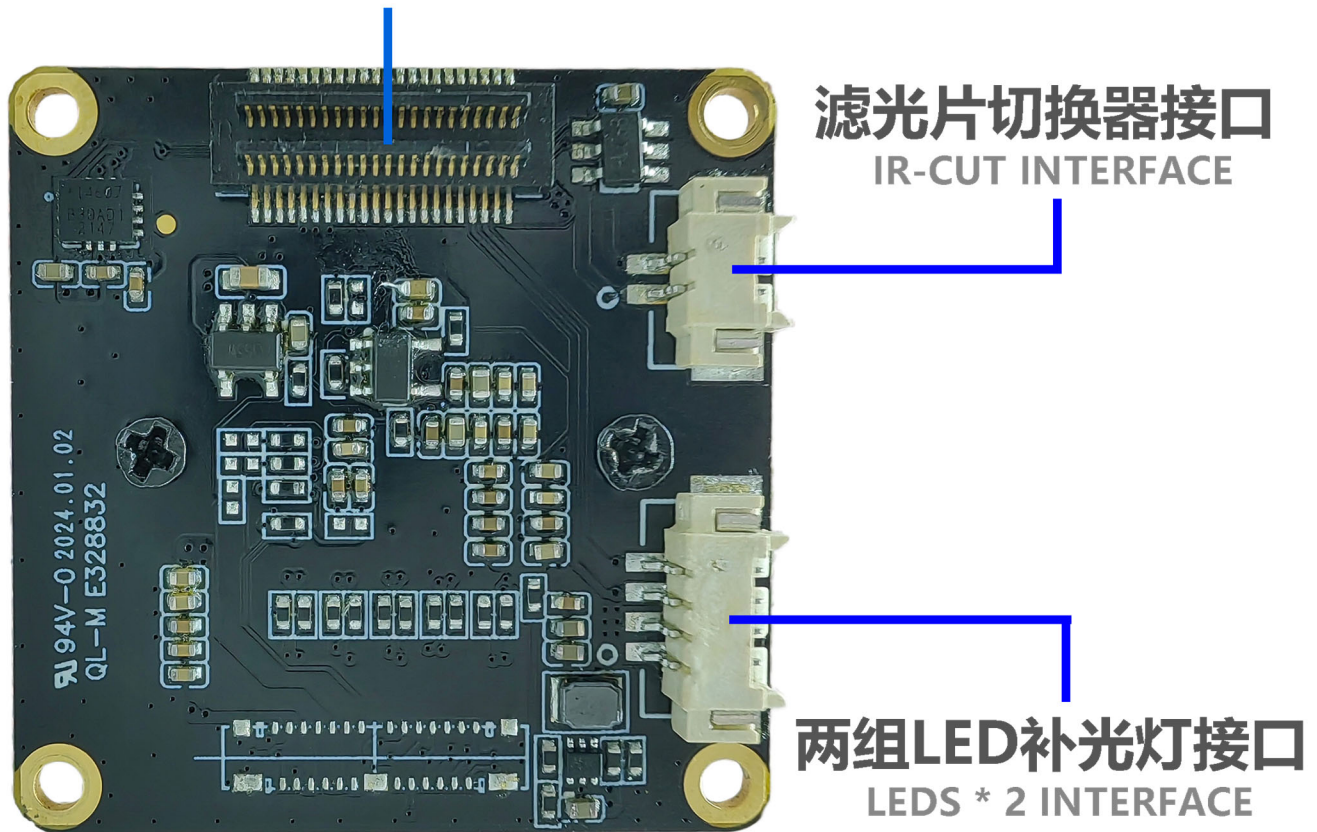

The IR-Cut filter switch interface is used by lenses with filters. Users need to match the lens that supports the IR-Cut switch structure in order to support this function.

The two sets of fill light interfaces support the expansion of infrared light and white light boards to provide fill light for the device. If you need the fill light function, you need to add the YDS-LEDP V2.0 White and Infrared Light LED Plate.

## YDS-CMFL0272-IMX586 V1.0 48MP Sony IMX586 Fixed Focus Camera Module

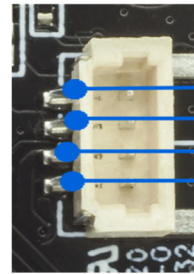
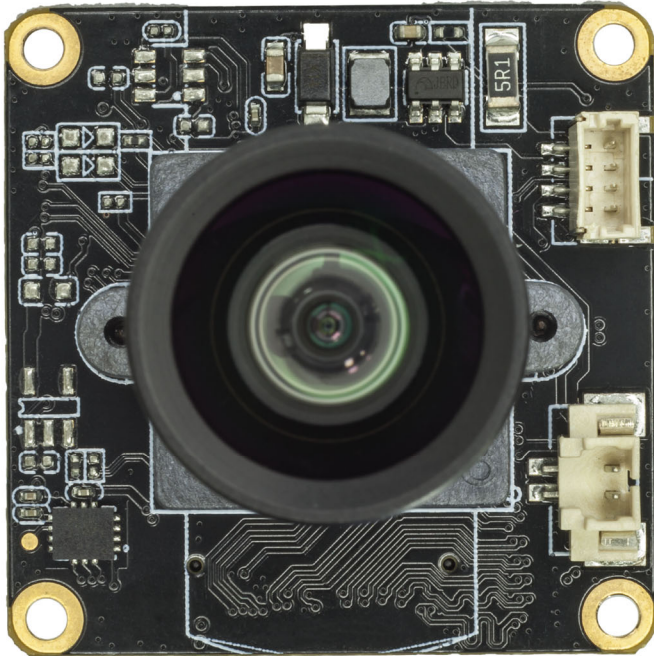

LED B -  
LED B +  
LED A -  
LED A +

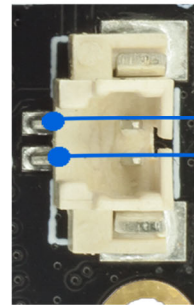

IR-CUT -  
IR-CUT +

The two groups of fill light interfaces support the expansion of infrared lights and white light boards to provide fill light for the device. Note: The IR-Cut filter switch interface is used by lenses with filters, but this camera module does not support this function.

Diagonal 8.000 mm (Type 1/2.0) 48Mega-Pixel CMOS Image Sensor with Square Pixel for Color Cameras

## IMX586-AAJH5-C

---

### General description and application

IMX586 is a diagonal 8.000 mm (Type 1/2.0) 48 Mega-pixel CMOS active pixel type stacked image sensor with a square pixel array. It adopts Sony's back-illuminated and stacked CMOS image sensor to achieve high speed image capturing by column parallel A/D converter circuits and high sensitivity and low noise image (comparing with conventional CMOS image sensor) through the backside illuminated imaging pixel structure. R, G, and B pigment primary color mosaic filter is employed. It operates with five power supply voltages: analog 2.9 V and 1.8V, digital 1.1 V, PLL-PHY 1.1V and 1.8 V for input/output interface and achieves low power consumption.

In addition, this product is designed for use in cellular phone and tablet PC. When using this for another application, Sony Semiconductor Solutions Corporation does not guarantee the quality and reliability of product. Therefore, don't use this for applications other than cellular phone and tablet PC. Consult your Sony Semiconductor Solutions Corporation sales representative if you have any questions.

---

### Functions and Features

- ◆ Back-illuminated and stacked CMOS image sensor
- ◆ Quad Bayer Coding color filter arrangement
- ◆ Phase Detection Auto Focus (PDAF)
- ◆ High Frame Rate 30fps@Full resolution (QBC Re-mosaic) / 30fps@QBC-HDR / 120fps@2x2 Adjacent Pixel Binning (16:9) / 240fps@2x2 Adjacent Pixel Binning V2H2(16:9)
- ◆ High signal to noise ratio(SNR)
- ◆ Dual sensor synchronization operation
- ◆ Built-in 2D Dynamic Defect Pixel Correction
- ◆ Lens Shading Correction (LSC)
- ◆ Built-in temperature sensor
- ◆ Output video format of RAW10/8, COMP8
- ◆ QBC Re-mosaic function
- ◆ QBC HDR function
- ◆ Two PLLs for independent clock generation for pixel control and data output interface
- ◆ CSI-2 serial data output
  - MIPI D-PHY 2lane/4lane, Max. 2.5Gbps/lane, D-PHY spec. ver. 1.2 compliant
  - MIPI C-PHY 1/2/3trio, Max 2.5Gbps/Trio, C-PHY spec ver. 1.0 compliant
- ◆ 2-wire serial communication (Supports I<sup>2</sup>C "Fast mode" and "Fast-mode Plus")
- ◆ 28K bit of OTP ROM for users

Sony Semiconductor Solutions Corporation reserves the right to change products and specifications without prior notice.

This information does not convey any license by any implication or otherwise under any patents or other right.

Application circuits shown, if any, are typical examples illustrating the operation of the devices. Sony Semiconductor Solutions Corporation cannot assume responsibility for any problems arising out of the use of these circuits.

## Device Structure

◆ CMOS image sensor	
◆ Image size	: Diagonal 8.000 mm (Type 1/2.0)
◆ Total number of pixels	: 8032 (H) × 6248 (V) approx. 50.18 M pixels
◆ Number of effective pixels	: 8032 (H) × 6088 (V) approx. 48.89 M pixels
◆ Number of active pixels	: 8000 (H) × 6000 (V) approx. 48.00 M pixels
◆ Chip size	: 7.504 mm (H) × 5.659 mm (V)
◆ Unit cell size	: 0.80 μm (H) × 0.80 μm (V)
◆ Substrate material	: Silicon

## Absolute Maximum Ratings

Item	Symbol	Ratings	Unit	notes
Supply voltage (analog1)	VANA1	-0.3 to +4.2	V	refer to VSS level
Supply voltage (analog2)	VANA2	-0.3 to +2.52	V	
Supply voltage (digital1, digital2(PLL-PHY))	VDIG1,2	-0.3 to +1.54	V	
Supply voltage (interface)	VIF	-0.3 to +2.52	V	
Input voltage (digital)	VI	-0.3 to +2.52	V	
Output voltage (digital)	VO	-0.3 to +2.52	V	
Guaranteed Operating temperature	TOPR	-20 to +70	°C	
Guaranteed storage temperature	TSTG	-30 to +80	°C	
Guaranteed performance temperature	TSPEC	-20 to +60	°C	

## Recommended Operating Voltage

Item	Symbol	Ratings	Unit	notes
Supply voltage (analog1)	VANA1	2.9 ± 0.1	V	refer to VSS level
Supply voltage (analog2)	VANA2	1.8 ± 0.1	V	
Supply voltage (digital1, digital2(PLL-PHY))	VDIG1,2	1.1 ± 0.1	V	
Supply voltage (interface)	VIF	1.8 ± 0.1	V	



## Cameras Applications



Automotive Driver Pilot



Live Streaming



Video Conference



Eye Tracker Biometric Detection

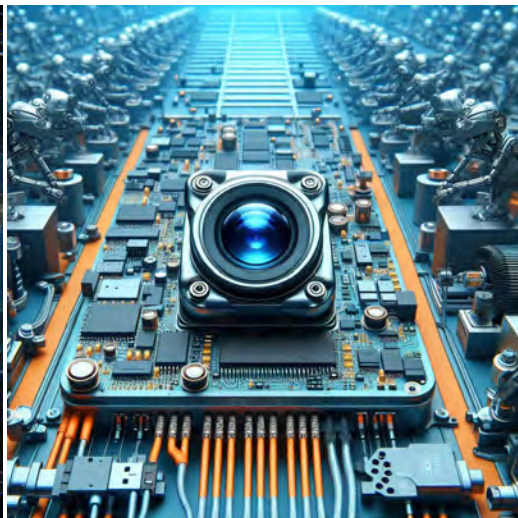

Machine Vision



Agricultural Monitor



Night Vision Security



Drone and Sports Eagle Eyes



Interactive Pet Camera



# YDS CAMERA MODULE

*your best camera partner*

## Camera Module Pinout Definition Reference Chart

OmniVision	Sony	Samsung	On-Semi	Aptina	Himax	GalaxyCore	PixArt	SmartSens	Sensors
Pin Signal		Description							
DGND GND		ground for digital circuit							
AGND		ground for analog circuit							
PCLK DCK		DVP PCLK output							
XCLR PWDN XSHUTDOWN STANDBY		power down active high with internal pull-down resistor							
MCLK XVCLK XCLK INCK		system input clock							
RESET RST		reset active low with internal pull-up resistor							
NC NULL		no connect							
SDA SIO_D SIOD		SCCB data							
SCL SIO_C SIOC		SCCB input clock							
VSYNC XVS FSYNC		DVP VSYNC output							
HREF XHS		DVP HREF output							
DOVDD		power for I/O circuit							
AFVDD		power for VCM circuit							
AVDD		power for analog circuit							
DVDD		power for digital circuit							
STROBE FSTROBE		strobe output							
FSIN		synchronize the VSYNC signal from the other sensor							
SID		SCCB last bit ID input							
ILPWM		mechanical shutter output indicator							
FREQ		frame exposure / mechanical shutter							
GPIO		general purpose inputs							
SLASEL		I2C slave address select							
AFEN		CEN chip enable active high on VCM driver IC							
<b>MIPI Interface</b>									
MDN0 DN0 MD0N DATA_N DMO1N		MIPI 1st data lane negative output							
MDP0 DP0 MD0P DATA_P DMO1P		MIPI 1st data lane positive output							
MDN1 DN1 MD1N DATA2_N DMO2N		MIPI 2nd data lane negative output							
MDP1 DP1 MD1P DATA2_P DMO2P		MIPI 2nd data lane positive output							
MDN2 DN2 MD2N DATA3_N DMO3N		MIPI 3rd data lane negative output							
MDP2 DP2 MD2P DATA3_P DMO3P		MIPI 3rd data lane positive output							
MDN3 DN3 MD3N DATA4_N DMO4N		MIPI 4th data lane negative output							
MDP3 DP3 MD3P DATA4_P DMO4P		MIPI 4th data lane positive output							
MCN CLKN CLK_N DCKN		MIPI clock negative output							
MCP CLKP MCP CLK_P DCKN		MIPI clock positive output							
<b>DVP Parallel Interface</b>									
D0 DO0 Y0		DVP data output port 0							
D1 DO1 Y1		DVP data output port 1							
D2 DO2 Y2		DVP data output port 2							
D3 DO3 Y3		DVP data output port 3							
D4 DO4 Y4		DVP data output port 4							
D5 DO5 Y5		DVP data output port 5							
D6 DO6 Y6		DVP data output port 6							
D7 DO7 Y7		DVP data output port 7							
D8 DO8 Y8		DVP data output port 8							
D9 DO9 Y9		DVP data output port 9							
D10 DO10 Y10		DVP data output port 10							
D11 DO11 Y11		DVP data output port 11							

[www.YDSCAM.com](http://www.YDSCAM.com) [sales@ydscam.com](mailto:sales@ydscam.com) Phone (WeChat, QQ): (+86) 177 2732 6718

All rights reserved @ YingDeShun Co. Ltd. Specifications subject to change without notice.

## Camera Reliability Test

Reliability Inspection Item		Testing Method	Acceptance Criteria	
Category	Item			
Environmental	Storage Temperature	High 60°C 96 Hours	Temperature Chamber	No Abnormal Situation
		Low -20°C 96 Hours	Temperature Chamber	No Abnormal Situation
	Operation Temperature	High 60°C 24 Hours	Temperature Chamber	No Abnormal Situation
		Low -20°C 24 Hours	Temperature Chamber	No Abnormal Situation
	Humidity	60°C 80% 24 Hours	Temperature Chamber	No Abnormal Situation
	Thermal Shock	High 60°C 0.5 Hours Low -20°C 0.5 Hours Cycling in 24 Hours	Temperature Chamber	No Abnormal Situation
Physical	Drop Test (Free Falling)	Without Package 60cm	10 Times on Wood Floor	Electrically Functional
		With Package 60cm	10 Times on Wood Floor	Electrically Functional
	Vibration Test	50Hz X-Axis 2mm 30min	Vibration Table	Electrically Functional
		50Hz Y-Axis 2mm 30min	Vibration Table	Electrically Functional
		50Hz Z-Axis 2mm 30min	Vibration Table	Electrically Functional
	Cable Tensile Strength Test	Loading Weight 4 kg 60 Seconds Cycling in 24 Hours	Tensile Testing Machine	Electrically Functional
Electrical	ESD Test	Contact Discharge 2 KV	ESD Testing Machine	Electrically Functional
		Air Discharge 4 KV	ESD Testing Machine	Electrically Functional
	Aging Test	On/Off 30 Seconds Cycling in 24 Hours	Power Switch	Electrically Functional
	USB Connector	On/Off 250 Times	Plug and Unplug	Electrically Functional



## Camera Inspection Standard

Inspection Item		Inspection Method	Standard of Inspection		
Category	Item				
Appearance	FPC/ PCB	Color	The Naked Eye	Major Difference is Not Allowed.	
		Be Torn/Chopped	The Naked Eye	Copper Crack Exposure is Not Allowed.	
		Marking	The Naked Eye	Clear, Recognizable (Within 30cm Distance)	
	Holder	Scratches	The Naked Eye	The Inside Crack Exposure is Not Allowed	
		Gap	The Naked Eye	Meet the Height Standard	
		Screw	The Naked Eye	Make Sure Screws Are Presented (If Any)	
		Damage	The Naked Eye	The Inside Crack Exposure is Not Allowed	
	Lens	Scratch	The Naked Eye	No Effect On Resolution Standard	
		Contamination	The Naked Eye	No Effect On Resolution Standard	
		Oil Film	The Naked Eye	No Effect On Resolution Standard	
		Cover Tape	The Naked Eye	No Issue On Appearance.	
	Function	Image	No Communication	Test Board	Not Allowed
			Bright Pixel	Black Board	Not Allowed In the Image Center
Dark Pixel			White board	Not Allowed In the Image Center	
Blurry			The Naked Eye	Not Allowed	
No Image			The Naked Eye	Not Allowed	
Vertical Line			The Naked Eye	Not Allowed	
Horizontal Line			The Naked Eye	Not Allowed	
Light Leakage			The Naked Eye	Not Allowed	
Blinking Image			The Naked Eye	Not Allowed	
Bruise			Inspection Jig	Not Allowed	
Resolution			Chart	Follows Outgoing Inspection Chart Standard	
Color			The Naked Eye	No Issue	
Noise			The Naked Eye	Not Allowed	
Corner Dark			The Naked Eye	Less Than 100px By 100px	
Color Resolution			The Naked Eye	No Issue	
Dimension	Height	The Naked Eye	Follows Approval Data Sheet		
	Width	The Naked Eye	Follows Approval Data Sheet		
	Length	The Naked Eye	Follows Approval Data Sheet		
	Overall	The Naked Eye	Follows Approval Data Sheet		

## YDSCAM Package Solutions

YDS Camera Module



Complete with Lens Protection Film

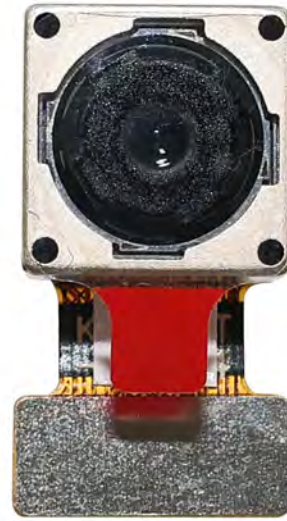

Tray with Grid and Space



Place Cameras on the Tray

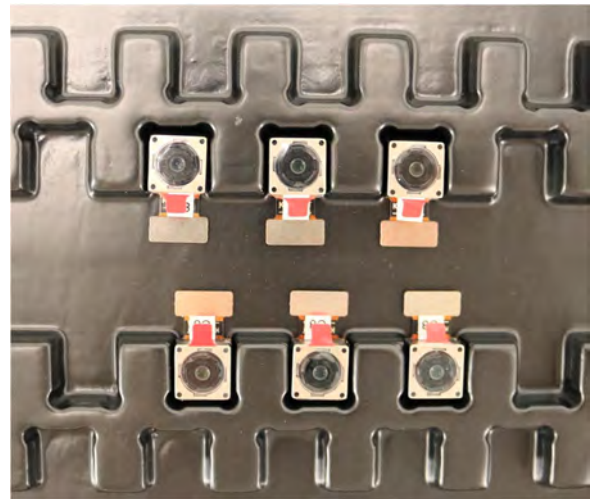

## YDSCAM Package Solutions

Full Tray of Cameras

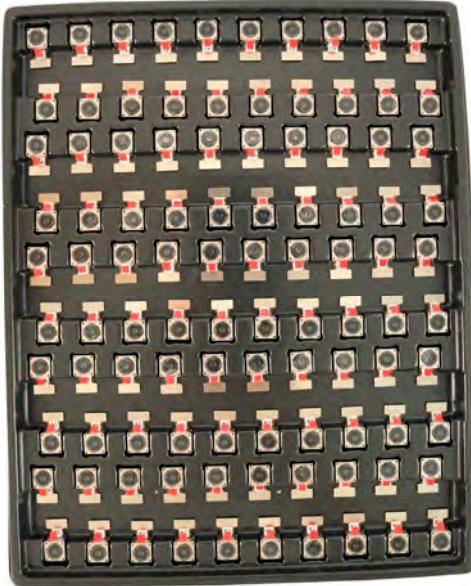

Cover Tray with Lid

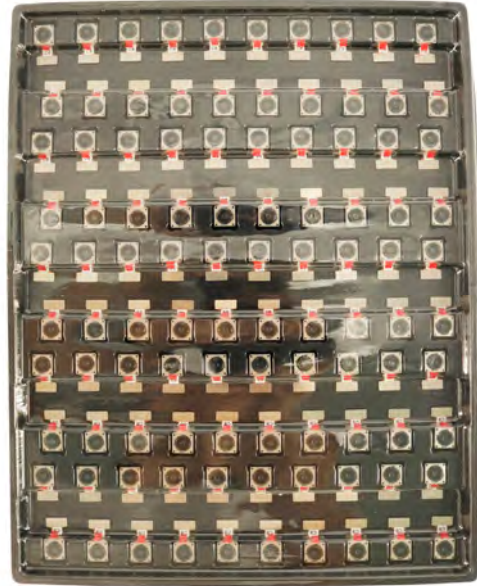

Place Tray into Anti-Static Bag



Vacuum the Anti-Static Bag



## YDSCAM Package Solutions

### Sealed Vacuum Anti-Static Bag with Labels

1. Model and Description 2. Quantity 3. Manufacturing Date Code 4. Caution



## YDSCAM Package Solutions

Place Foam Sheets Between Tray Bags



Foam Sheets are Larger Than Trays



Place Foam Sheets and Trays into Box



Foam Sheets are Tightly Fitting in Box



Seal the Carbon Box



Label the Carbon Shipping Box







## YDSCAM Package Solutions

USB Camera Module

Complete with Lens Protection Film

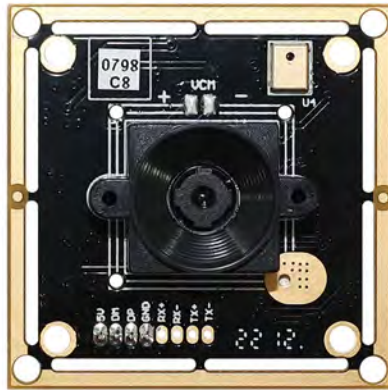

Place Camera Sample into Anti-Static Bag

Place USB Cameras into Tray



Seal the Tray with Anti-Static Bag

Label the Carbon Shipping Box



## YDSCAM Package Solutions

Place Camera Sample into Anti-Static Bag



Place Connectors into Anti-Static Bag



Label the Sample Bags



Place Connectors into Reel



Place Samples into the Carbon Box



Place Connectors into the Carbon Box





# YDS CAMERA MODULE

*your best camera partner*

## Company YDSCAM

YingDeShun Co. Ltd. (YDS) was established in 2017, a next-generation technology driven manufacturer specialized in research, design, and produce of audio and video products. YDS is occupying 20,000 square feet automated plants with 100 employees of annual throughput 30,000,000 units cameras.

YDS provides OEM, ODM design, contract manufacturing, and builds the camera products. You may provide the requirements to us, even with a hand draft, our sales and engineering work together to meet your needs. We consider ourselves your last-term partner in developing practical and innovative solutions.

Our team covers everything from initial concept development to mass produced product. YDS specializes in customized camera design, raw material, electronic engineering, firmware/software development, product testing, and packing design. Our experienced strategic supply systems offer a robust and dependable manufacturing capacity for orders of various sizes.

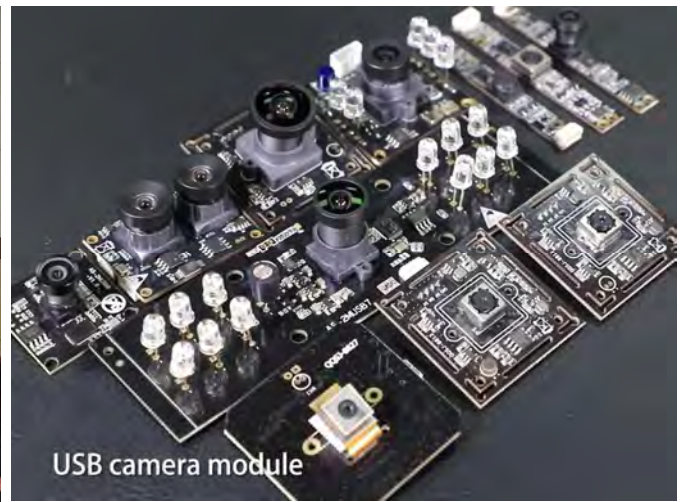

## Limited Warranty

YDS provides the following limited warranty if you purchased the Product(s) directly from YDS company or from YDS's website [www.YDSCAM.com](http://www.YDSCAM.com). Product(s) purchased from other sellers or sources are not covered by this Limited Warranty. YDS guarantees that the Product(s) will be free from defects in materials and workmanship under normal use for a period of one (1) year from the date you receive the product ("Warranty Period").

For all Product(s) that contain or develop material defects in materials or workmanship during the Warranty Period, YDS will, at its sole option, either: (i) repair the Product(s); (ii) replace the Product(s) with a new or refurbished Product(s) (replacement Product(s) being of identical model or functional equivalent); or (iii) provide you a refund of the price you paid for the Product(s).

This Limited Warranty of YDS is solely limited to repair and/or replacement on the terms set forth above. YDS is not reliable or responsible for any subsequent events.



[www.YDSCAM.com](http://www.YDSCAM.com) [sales@ydscam.com](mailto:sales@ydscam.com) Phone (WeChat, QQ): (+86) 177 2732 6718

All rights reserved @ YingDeShun Co. Ltd. Specifications subject to change without notice.



# YDS CAMERA MODULE

*your best camera partner*

## YDS Strength

### Powerful Factory



### Professional Service



### Promised Delivery



[www.YDSCAM.com](http://www.YDSCAM.com) [sales@ydscam.com](mailto:sales@ydscam.com) Phone (WeChat, QQ): (+86) 177 2732 6718

All rights reserved @ YingDeShun Co. Ltd. Specifications subject to change without notice.